

ESC Carrier to ESCs

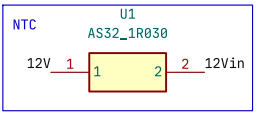
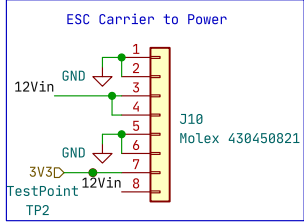
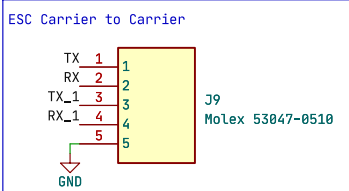
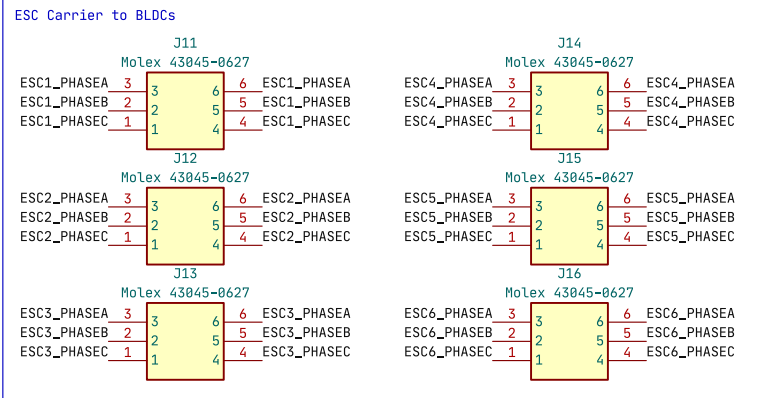
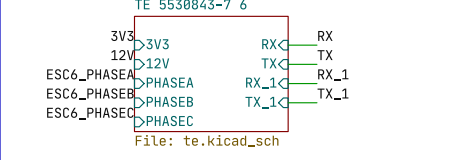
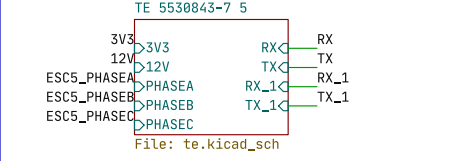
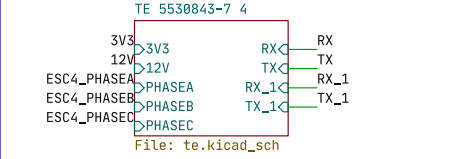
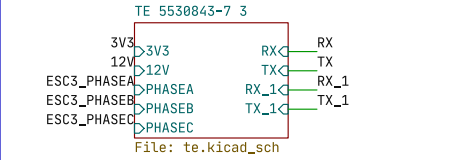
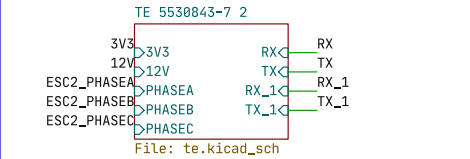
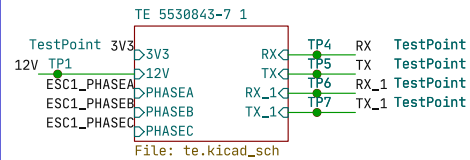

The MUREX ESC Carrier board is designed for rapid replacement of components in the event of a speed controller failure.  
 //DREAM BIG. DREAM MUREX.  
 //CONTINUOUS EVOLUTION.  
 MUREX Robotics [CeLine Zhang]

Sheet: /  
 File: ESC\_Carrier.kicad\_sch

Title: MUREX ESC Carrier Board

Size: A4	Date: 2023-08-21	Rev: V2.0
KiCad E.D.A.	kicad 7.99.0-957-g18dd623122	Id: 1/7



The MUREX ESC Carrier board is designed for rapid replacement of components in the event of a speed controller failure.  
 //DREAM BIG. DREAM MUREX.  
 //CONTINUOUS EVOLUTION.  
 MUREX Robotics [Celine Zhang]

Sheet: /TE 5530843-7 2/  
 File: te.kicad\_sch

**Title: MUREX ESC Carrier Board**

Size: A4	Date: 2023-08-21	Rev: V2.0
KiCad E.D.A.	kicad 7.99.0-957-g18dd623122	Id: 3/7



The MUREX ESC Carrier board is designed for rapid replacement of components in the event of a speed controller failure.  
 //DREAM BIG. DREAM MUREX.  
 //CONTINUOUS EVOLUTION.  
 MUREX Robotics [Celine Zhang]

Sheet: /TE 5530843-7 3/  
 File: te.kicad\_sch

**Title: MUREX ESC Carrier Board**

Size: A4	Date: 2023-08-21	Rev: V2.0
KiCad E.D.A.	kicad 7.99.0-957-g18dd623122	Id: 5/7



The MUREX ESC Carrier board is designed for rapid replacement of components in the event of a speed controller failure.  
 //DREAM BIG. DREAM MUREX.  
 //CONTINUOUS EVOLUTION.  
 MUREX Robotics [Celine Zhang]

Sheet: /TE 5530843-7 4/  
 File: te.kicad\_sch

**Title: MUREX ESC Carrier Board**

Size: A4	Date: 2023-08-21	Rev: V2.0
KiCad E.D.A.	kicad 7.99.0-957-g18dd623122	Id: 7/7



The MUREX ESC Carrier board is designed for rapid replacement of components in the event of a speed controller failure.  
 //DREAM BIG. DREAM MUREX.  
 //CONTINUOUS EVOLUTION.  
 MUREX Robotics [Celine Zhang]

Sheet: /TE 5530843-7 5/  
 File: te.kicad\_sch

**Title: MUREX ESC Carrier Board**

Size: A4	Date: 2023-08-21	Rev: V2.0
KiCad E.D.A.	kicad 7.99.0-957-g18dd623122	Id: 9/7



The MUREX ESC Carrier board is designed for rapid replacement of components in the event of a speed controller failure.  
 //DREAM BIG. DREAM MUREX.  
 //CONTINUOUS EVOLUTION.  
 MUREX Robotics [Celine Zhang]  
 Sheet: /TE 5530843-7 6/  
 File: te.kicad\_sch

---

**Title: MUREX ESC Carrier Board**

Size: A4	Date: 2023-08-21	Rev: V2.0
KiCad E.D.A.	kicad 7.99.0-957-g18dd623122	Id: 11/7



The MUREX ESC Carrier board is designed for rapid replacement of components in the event of a speed controller failure.  
 //DREAM BIG. DREAM MUREX.  
 //CONTINUOUS EVOLUTION.  
 MUREX Robotics [Celine Zhang]

Sheet: /TE 5530843-7 1/  
 File: te.kicad\_sch

**Title: MUREX ESC Carrier Board**

Size: A4	Date: 2023-08-21	Rev: V2.0
KiCad E.D.A.	kicad 7.99.0-957-g18dd623122	Id: 18/7